



DVD-LS90

Panasonic®

Operating Instructions Portable DVD/CD Player

Model No. **DVD-LS90**
DVD-LS93

Dear customer

Thank you for purchasing this product.
For optimum performance and safety, please read these instructions carefully.
Before connecting, operating or adjusting this product, please read the instructions completely.
Please keep this manual for future reference.

Operations in these instructions are described mainly with the main unit, but you can do the operations on the remote control if the remote controls are the same (→ Back cover)

Unless otherwise indicated, illustrations in these operating instructions are of DVD-LS90.

MULTI-FORMAT PLAYBACK

DVD-RAM

recorded with DVD video recorders etc.

Video & Still pictures (JPEG)

DVD-RW (DVD-VR)

recorded and finalized with DVD video recorders etc.

DVD-Video/Video CD/CD

sold on the market

Movie, Music etc.

DVD-R/DVD-RW/+R/+RW

recorded and finalized with DVD video recorders etc.

Video (played as DVD-Video)

CD-R/CD-RW

recorded and finalized with personal computers etc.

Music (WMA/MP3) & Still pictures (JPEG)

See page 5 for details.



For U.S.A.:

The warranty can be found on page 28.

For Canada:

The warranty can be found on page 30.

PalmTheater



If you have any questions contact

In the U.S.A.: 1-800-211-PANA(7262)

In Canada: 1-800-561-5505



This manual was printed with soy based ink.



RQT8067-3P

WARNING:

TO REDUCE THE RISK OF FIRE, ELECTRIC SHOCK OR PRODUCT DAMAGE, DO NOT EXPOSE THIS APPARATUS TO RAIN, MOISTURE, DRIPPING OR SPLASHING AND THAT NO OBJECTS FILLED WITH LIQUIDS, SUCH AS VASES, SHALL BE PLACED ON THE APPARATUS.

CAUTION!

- DO NOT INSTALL OR PLACE THIS UNIT IN A BOOKCASE, BUILT-IN CABINET OR IN ANOTHER CONFINED SPACE. ENSURE THE UNIT IS WELL VENTILATED. TO PREVENT RISK OF ELECTRIC SHOCK OR FIRE HAZARD DUE TO OVERHEATING, ENSURE THAT CURTAINS AND ANY OTHER MATERIALS DO NOT OBSTRUCT THE VENTILATION VENTS.
- DO NOT OBSTRUCT THE UNIT'S VENTILATION OPENINGS WITH NEWSPAPERS, TABLECLOTHS, CURTAINS, AND SIMILAR ITEMS.
- DO NOT PLACE SOURCES OF NAKED FLAMES, SUCH AS LIGHTED CANDLES, ON THE UNIT.
- DISPOSE OF BATTERIES IN AN ENVIRONMENTALLY FRIENDLY MANNER.

THE FOLLOWING APPLIES ONLY IN THE U.S.A. AND CANADA
The following mark and symbols are located on bottom of the unit.



CAUTION

RISK OF ELECTRIC SHOCK
DO NOT OPEN



CAUTION: TO REDUCE THE RISK OF ELECTRIC SHOCK, DO NOT REMOVE SCREWS. NO USER-SERVICEABLE PARTS INSIDE. REFER SERVICING TO QUALIFIED SERVICE PERSONNEL.



The lightning flash with arrowhead symbol, within an equilateral triangle, is intended to alert the user to the presence of uninsulated "dangerous voltage" within the product's enclosure that may be of sufficient magnitude to constitute a risk of electric shock to persons.



The exclamation point within an equilateral triangle is intended to alert the user to the presence of important operating and maintenance (servicing) instructions in the literature accompanying the appliance.

Marking sign is located on bottom of the unit.

CAUTION- LASER RADIATION WHEN OPEN AND INTERLOCK DEFEATED. DO NOT STARE INTO BEAM. FDA 21 CFR / Class II

CAUTION- VISIBLE AND INVISIBLE LASER RADIATION WHEN OPEN AND INTERLOCKS DEFEATED.

AVOID EXPOSURE TO BEAM. IEC60825-1/ Class 3b

ATTENTION- RAYONNEMENT LASER VISIBLE ET INVISIBLE DANGEREUX EN CAS D'OUVERTURE ET LORSQUE LA SÉCURITÉ EST NEUTRALISÉE.

EXPOSITION DANGEREUSE AU FAISCEAU.

(Bottom of product)

THE FOLLOWING APPLIES ONLY IN THE U.S.A. CAUTION:

This equipment has been tested and found to comply with the limits for a Class B digital device, pursuant to Part 15 of the FCC Rules. These limits are designed to provide reasonable protection against harmful interference in a residential installation. This equipment generates, uses and can radiate radio frequency energy and, if not installed and used in accordance with the instructions, may cause harmful interference to radio communications. However, there is no guarantee that interference will not occur in a particular installation. If this equipment does cause harmful interference to radio or television reception, which can be determined by turning the equipment off and on, the user is encouraged to try to correct the interference by one or more of the following measures:

- Reorient or relocate the receiving antenna.
- Increase the separation between the equipment and receiver.
- Connect the equipment into an outlet on a circuit different from that to which the receiver is connected.
- Consult the dealer or an experienced radio/TV technician for help.

Any unauthorized changes or modifications to this equipment would void the user's authority to operate this device.

This device complies with Part 15 of the FCC Rules. Operation is subject to the following two conditions: (1) This device may not cause harmful interference, and (2) this device must accept any interference received, including interference that may cause undesired operation.

WARNING:

The driver must not operate this unit while the vehicle is moving.
 Do not operate this unit where it can be viewed by the driver.
 Driver operation or viewing of this unit while the vehicle is moving will cause distraction which may result in serious accident and personal injury or property damage.

CAUTION!

THIS PRODUCT UTILIZES A LASER. USE OF CONTROLS OR ADJUSTMENTS OR PERFORMANCE OF PROCEDURES OTHER THAN THOSE SPECIFIED HEREIN MAY RESULT IN HAZARDOUS RADIATION EXPOSURE. DO NOT OPEN COVERS AND DO NOT REPAIR YOURSELF. REFER SERVICING TO QUALIFIED PERSONNEL.

CAUTION!

DANGER OF EXPLOSION IF BATTERY IS INCORRECTLY REPLACED.

REPLACE ONLY WITH THE SAME OR EQUIVALENT TYPE RECOMMENDED BY THE MANUFACTURER. DISCARD USED BATTERIES ACCORDING TO THE MANUFACTURER'S INSTRUCTIONS.

AC adaptor

This AC adaptor operates on AC between 100 V and 240 V.

But

- In the U.S.A. and Canada, the AC power supply cord must be connected to a 120 V AC power supply only.
- When connecting to an AC supply outside of the U.S.A. or Canada, use a plug adaptor to suit the AC outlet configuration.
- When connecting to a supply of greater than AC 125 V, ensure the cord you use is suited to the voltage of the AC supply and the rated current of the AC adaptor.
- Contact an electrical parts distributor for assistance in selecting a suitable AC plug adaptor or AC cord set.

The socket outlet shall be installed near the equipment and easily accessible or the mains plug or an appliance coupler shall remain readily operable.

This product may receive radio interference caused by mobile telephones during use. If such interference is apparent, please increase separation between the product and the mobile telephone.

THIS UNIT IS INTENDED FOR USE IN MODERATE CLIMATES.

Table of contents

IMPORTANT SAFETY INSTRUCTIONS 4

Accessories 5

Discs that can be played 5

Preparations

① *Attaching the battery* 6

② *Recharging the battery* 6

③ *The remote control* 7

④ *Adjusting the LCD angle* 7

Play 8

Useful functions 10

Enjoying higher quality audio and video 12

Program/Random play 13

Playing data discs 14

Playing HighMAT™ discs 15

Playing programs/playlists on RAM/DVD-RW (DVD-VR) discs 15

Playing CD 15

Using On-Screen Menus 16

Changing the player settings 18

Using this unit with other equipment 20

Using a Car DC Adaptor (included) 21

Frequently asked questions 22

Tips for making WMA/MP3 and JPEG discs (For CD-R/CD-RW) 22

Specifications 23

Troubleshooting guide 24

Maintenance 27

Limited Warranty (ONLY FOR U.S.A.) 28

Product Service 29

Limited Warranty (ONLY FOR CANADA) 30

Main feature index Back cover

THE FOLLOWING APPLIES ONLY IN THE U.S.A.

Notice:

This product has parts that contains a small amount of mercury. It also contains lead in some components. Disposal of these materials may be regulated in your community due to environmental considerations. For disposal or recycling information please contact your local authorities, or the Electronics Industries Alliance: <http://www.eiae.org.>

IMPORTANT SAFETY INSTRUCTIONS

Read these operating instructions carefully before using the unit. Follow the safety instructions on the unit and the applicable safety instructions listed below. Keep these operating instructions handy for future reference.

- 1) Read these instructions.
- 2) Keep these instructions.
- 3) Heed all warnings.
- 4) Follow all instructions.
- 5) Do not use this apparatus near water.
- 6) Clean only with dry cloth.
- 7) Do not block any ventilation openings.
Install in accordance with the manufacturer's instructions.
- 8) Do not install near any heat sources such as radiators, heat registers, stoves, or other apparatus (including amplifiers) that produce heat.
- 9) Do not defeat the safety purpose of the polarized or grounding-type plug. A polarized plug has two blades with one wider than the other. A grounding-type plug has two blades and a third grounding prong. The wide blade or the third prong are provided for your safety. If the provided plug does not fit into your outlet, consult an electrician for replacement of the obsolete outlet.
- 10) Protect the power cord from being walked on or pinched particularly at plugs, convenience receptacles, and the point where they exit from the apparatus.
- 11) Only use attachments/accessories specified by the manufacturer.
- 12) Use only with the cart, stand, tripod, bracket, or table specified by the manufacturer, or sold with the apparatus. When a cart is used, use caution when moving the cart/apparatus combination to avoid injury from tip-over.
- 13) Unplug this apparatus during lightning storms or when unused for long periods of time.
- 14) Refer all servicing to qualified service personnel. Servicing is required when the apparatus has been damaged in any way, such as power-supply cord or plug is damaged, liquid has been spilled or objects have fallen into the apparatus, the apparatus has been exposed to rain or moisture, does not operate normally, or has been dropped.



Batteries

1. Battery pack (Lithium ion battery pack)

- Use this unit to recharge the battery pack.
- Do not use the battery pack with equipment other than the specified player.
- Do not use the player outside if it is snowing or raining. (The battery pack is not waterproof.)
- Do not get dirt, sand, liquids, or other foreign matter on the terminals.
- Do not touch the plug terminals (+ and -) with metal objects.
- Do not disassemble, remodel, heat or throw into fire.

2. Button-type battery (Lithium battery)

- Insert with poles aligned.
- Do not touch the terminals (+ and -) with metal objects.
- Do not disassemble, remodel, heat or throw into fire.
- Keep out of reach of children

If any electrolyte should come into contact with your hands or clothes, wash it off thoroughly with water.

If any electrolyte should come into contact with your eyes, never rub the eyes. Rinse eyes thoroughly with water, and then consult a doctor.

3. Disposing of the batteries

Check and follow your local regulations before disposal.

CAUTION:

The batteries used in this device may present a risk of fire or chemical burn if mistreated. Do not disassemble or incinerate the batteries. Do not heat the batteries above the following temperatures.

Button-type battery 100 °C (212 °F)

Battery pack 60 °C (140 °F)

Do not recharge the button-type battery. Replace only with Panasonic part number indicated below:

Button-type battery (Lithium battery)
(for remote control) **CR2025**

Battery pack
(Lithium ion battery pack)

CGR-H702
CGR-H703

Use of other batteries may present a risk of fire or explosion.

THE FOLLOWING APPLIES ONLY IN THE U.S.A. AND CANADA

A lithium ion/polymer battery that is recyclable powers the product you have purchased. Please call 1-800-8-BATTERY for information on how to recycle this battery.



Accessories



Use numbers indicated in parentheses when asking for replacement parts. (Product numbers correct as of February 2005. These may be subject to change.)
(Only for U.S.A.) To order accessories, refer to "Accessory Purchases" on page 29.
 (For other areas) To order accessories, call the dealer from whom you have made your purchase.

- 1 Remote control** (N2QAHC000021)
- 1 Rechargeable battery pack**
DVD-LS90 (CGR-H702)
DVD-LS93 (CGR-H703)
 For replacement: Available from Panasonic dealers
- 1 Button-type battery** for remote control
 (for replacement, see page 7.)
- 1 Audio/video cable** (K2KA6CB00003)
- 1 AC adaptor** (RFEA213W)
- 1 AC power supply cord** (K2CB2CB00006)
- 1 Car DC Adaptor** (RFEC201M)

- The included AC power supply cord and AC adaptor are for use with this unit only. Do not use them with other equipment.
- **Optional battery pack** (Lithium ion battery pack) CGR-H703, CGR-H702

Discs that can be played

Operations in these instructions are described mainly with reference to specific formats. Icons such as **RAM** show the formats.

	DVD-RAM RAM JPEG <ul style="list-style-type: none"> • RAM Recorded with devices using Version 1.1 of the Video Recording Format (a unified video recording standard), such as DVD video recorders, DVD video cameras, personal computers, etc. • JPEG Recorded with Panasonic DVD-Video recorders using DCF (Design rule for Camera File system) Standard Version 1.0. To play JPEG files, select "Play as Data Disc" (→ page 17, Other Menu).
	DVD-Video DVD-V Discs marked with labels containing the region number "1" or "ALL" Example:
	DVD-R (DVD-Video)/DVD-RW (DVD-Video) DVD-V Discs recorded and finalized* on DVD video recorders or DVD video cameras DVD-RW (DVD-VR) DVD-RW (VR) Discs recorded and finalized* on DVD video recorders or DVD video cameras using Version 1.1 of the Video Recording Format (a unified video recording standard).
—	+R (Video)/+RW (Video) DVD-V Discs recorded and finalized* on DVD video recorders or DVD video cameras
	Video CD VCD Including SVCD (Conforming to IEC62107)
	CD CD WMA MP3 JPEG VCD <ul style="list-style-type: none"> • This unit can play CD-R/RW recorded with the above formats. Close the sessions or finalize* the disc after recording. • WMA MP3 JPEG This unit also plays HighMAT discs.

*A process that allows play on compatible equipment.

- It may not be possible to play the above discs in all cases due to the type of disc or condition of the recording.

■ Discs that cannot be played

DVD-Audio, DVD-ROM, Version 1.0 of DVD-RW, CD-ROM, CD-V, CD-G, SACD, DivX Video Discs and Photo CD, DVD-RAM that cannot be removed from their cartridges, 2.6-GB and 5.2-GB DVD-RAM, PAL discs and "Chaoji VCD" available on the market including CVD, DVCD and SVCD that do not conform to IEC62107.

Note about using a DualDisc

- The digital audio content side of a DualDisc does not meet the technical specifications of the Compact Disc Digital Audio (CD-DA) format so play may not be possible.
- Do not use a DualDisc in this unit as it may not be possible to insert it correctly and it may get scratched or scraped.

Preparations

① Attaching the battery (When the unit is off)

The illustrations show how to attach the CGR-H702. Attach CGR-H703 in the same way.

Bottom side of this unit

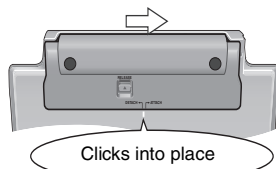
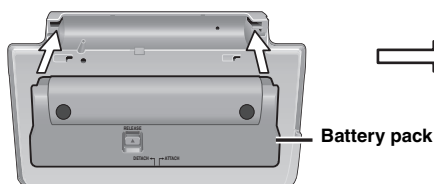

Check to make sure it is securely fastened.

Detaching

- Turn the unit off before detaching the battery pack.
- The illustrations show how to detach the CGR-H702. Detach CGR-H703 in the same way.

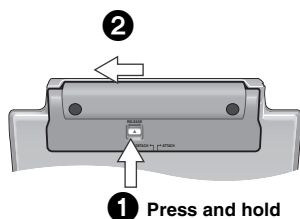

When not using for long periods of time

- Remove the battery pack (→ left).
(Even when the unit is turned off, there is a small amount of voltage running through the unit, and this may result in a malfunction.)
- Recharge the battery for re-use.

② Recharging the battery (When the unit is off)

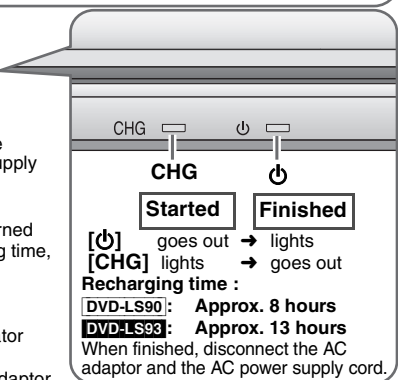
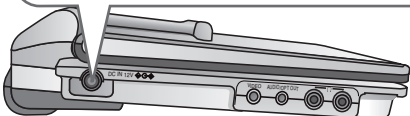
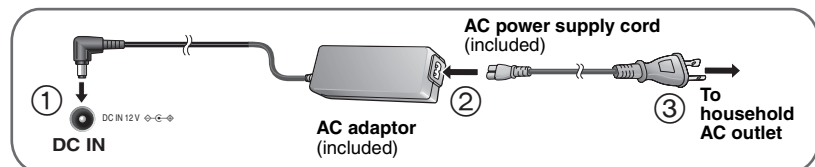

- You can also use this unit without charging while connecting the AC adaptor and the AC power supply cord.

To conserve power

This unit consumes 0.5 W of power even when turned off. When the unit is not going to be used for a long time, disconnect the AC power supply cord from the household AC outlet.

The unit is in the standby condition (the [⏻] indicator lights) when the AC mains lead is connected. The primary circuit is always "live" as long as the AC adaptor is connected to an electrical outlet.

Checking the remaining battery charge

When the unit is on (→ page 8) and powered by the battery pack
 Press [DISPLAY] to check on the LCD (Displays for a few seconds).

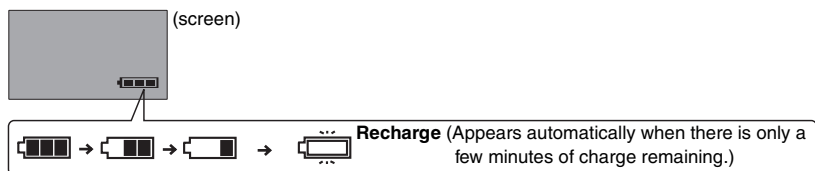

Approximate play times (Hours)

Battery pack	Play (at room temperature using headphones)			
	LCD brightness level			LCD Off
	-5	0 (factory preset)	+5	
CGR-H702	6	4	3	8
CGR-H703	10	8	6	16

- The times indicated above may differ depending on use.
- To change the LCD brightness (→ page 11, Adjusting the picture quality on the LCD).

3 The remote control

Insert the button-type battery (included)

Range of use

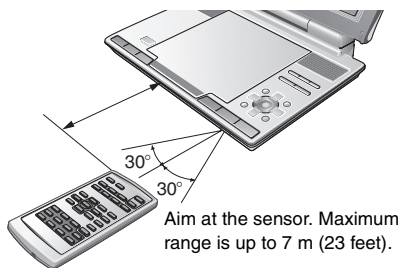
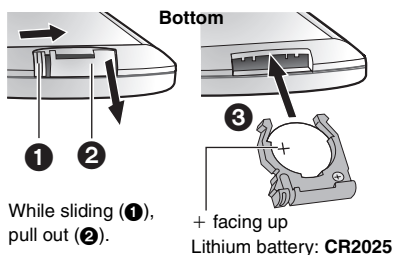

- Keep out of the small children.
- Accidental swallowing of batteries can result in stomach and intestinal damage.

4 Adjusting the LCD angle

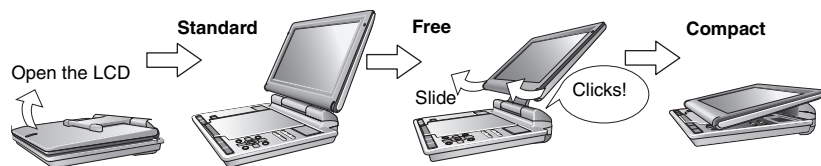

When moving the unit : Close the LCD. Don't hold by the LCD.

Play

1 Open the lid.



Headphone terminals [Ω]
3.5 mm (1/8") Stereo

2 Insert a disc and close the lid.



Load double-sided discs so the label for the side you want to play is facing up.

RAM Remove discs from their cartridges before use.

3 Press and hold.



The unit turns on and play begins.





4 Adjust the volume.





- While stopped, the unit automatically turns off once 15 minutes (after approximately 5 minutes when using the battery pack) have elapsed.
- Discs continue to rotate while menus are displayed. Press [■, -OFF] when you finish to preserve the unit's motor.
- Total title number may not be displayed properly on +R/+RW.
- If you are experiencing problems, refer to troubleshooting guide (→ page 24).

Main unit operations

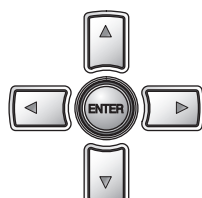
	Turn unit on/play	Press and hold and the power comes on and play begins.
	Pause	Press [▶, ON] to restart play.
	Stop	The position is memorized when "▶" flashes on the screen. <ul style="list-style-type: none"> • Press [▶, ON] to resume. • DVD-V While the message is displayed, press [▶, ON] and the previous chapters are reviewed. Opening the lid, or pressing [■, -OFF] while "▶" is flashing cancels the memorized position where play stopped.
	Turn unit off	Press and hold until "OFF" is displayed.

	Skip	Press [⏮ , ⏭]. RAM DVD-RW (VR) Can also skip to the markers.
	Search	Press and hold [⏮ , ⏭] (up to 5 steps).
	Slow play	Press and hold [⏮ , ⏭] (up to 5 steps) while paused. Press [▶ , ON] to return to normal play. VCD [⏭] only
TOP MENU 	Top menu	DVD-V
	Playing programs	RAM DVD-RW (VR) (→ page 15)
MENU 	Menu	DVD-V
	Playing playlists	RAM DVD-RW (VR) (→ page 15)
	Navigation menu	WMA MP3 JPEG (→ page 14)
RETURN 	Return	Returns to the previous screen. VCD (with playback control) Returns to the menu.
	Menu operation	Press [▲ ▼ ◀ ▶] to select an item and press [ENTER] to confirm.
	Frame-by-frame	While paused, press [◀ ▶]. VCD [▶] only
	Group skip	WMA MP3 JPEG Press [▲ ▼].

Remote control operations

	Skip	Press [⏮ , ⏭].
	Search	Press [⏮ , ⏭] (up to 5 steps).
	Slow play	Press [⏮ , ⏭] (up to 5 steps) while paused. Press [▶] (PLAY) to return to normal play. VCD [⏭] only
	Enter number	RAM DVD-RW (VR) DVD-V VCD CD e.g. To select 12: [≥10] → [1] → [2] VCD with playback control While stopped, press the numbered buttons. WMA MP3 JPEG e.g. To select 123: [1] → [2] → [3] → [ENTER]

• You cannot turn on the unit with the remote control if the unit is powered by the battery pack.

Useful functions

Repeat play (Only when the elapsed play time can be displayed.
For JPEG, you can use even if there is no elapsed time display.)



Press several times to select the content to repeat.



• To exit the screen : Press [RETURN].

To repeat a specified section (A-B Repeat)

Except [JPEG] and [RAM] [DVD-RW (VR)] (still picture part)

1 DISPLAY



Press once.

2



① Press [▲▼] to select Other Settings.

② Press [▶] to go to the next menu and [▲▼] to select "Play Menu".

③ Press [▶] to go to the next menu and [▲▼] to select "A-B Repeat".

④ Press [ENTER] at the starting and ending points.

• Press [ENTER] again to cancel.

• To exit the screen : Press [RETURN].



Changing play speed [RAM] [DVD-RW (VR)] [DVD-V]

1 DISPLAY



Press once.

2

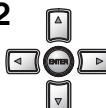

① Press [▲▼] to select Other Settings.

② Press [▶] to go to the next menu and [▲▼] to select "Play Speed".

③ Press [ENTER] and [▲▼] to select "Normal" or "×0.6" to "×1.4" (in 0.1 units).

④ Press [ENTER].

• Press [▶] (PLAY) to return to normal play.

• After you change the speed

– Advanced Surround (→ below) and Multi Re-master (→ page 12) do not work.

– Digital output switches to PCM-2ch.

– 96 kHz sampling frequency is converted to 48 kHz.

• This may not work depending on the disc's recording.

• To exit the screen : Press [RETURN].

Enjoying virtual surround (Advanced Surround)

[RAM] [DVD-RW (VR)] [DVD-V] [VCD] (2 or more channels)

A.SURROUND



Press to select "SP 1 Natural" or "SP 2 Enhanced".

A surround sound effect can be made using 2 speakers (on other equipment).

• When using headphones, press to select "HP 1 Natural" or "HP 2 Enhanced".

• When using discs recorded with surround sound, sound seems to come from speakers on either side of you.

• Optimum seating position is 3 to 4 times the distance between the front left and right speakers or the width of the television if using the television's speakers.

• Do not use in combination with surround effects on other equipment.

• To exit the screen : Press [RETURN].

Selecting how to show 4:3 aspect pictures on the LCD

MONITOR MODE  Press to select the monitor mode.

NORMAL: Normal

FULL: Stretched horizontally

ZOOM: Stretched vertically and horizontally

OFF: No picture

- If you are not using the LCD on this unit, select "OFF" to conserve power. (The [MONITOR] indicator flashes)
- The LCD turns off automatically if you close it.

Adjusting the picture quality on the LCD

1 **PICTURE MODE** 

2  Press [**▲▼**] to select the item, and [**◀▶**] to change the setting.

- To exit the screen : Press [PICTURE MODE].

Changing soundtracks **DVD-V** (with multiple soundtracks) **RAM** **DVD-RW (VR)** **VCD**

AUDIO  Press to select the soundtrack.

(Remote control)

 Menu
Audio 1

RAM **DVD-RW (VR)** **VCD**

You can use this button to select "L", "R" or "L R".

DVD-V (Karaoke discs)

Press [**◀▶**] to select "On" or "Off" for vocals.

Read the disc's instructions for details.

• To exit the screen : Press [RETURN].

Signal type/data

LPCM/□□ Digital/DTS/MPEG: Signal type
kHz (Sampling frequency)/bit/ch (Number of channels)
Example: 3/2 .1ch

- 1: Low frequency effect (not displayed if there is no signal)
- 0: No surround
- 1: Mono surround
- 2: Stereo surround (left/right)
- 1: Center
- 2: Front left+ Front right
- 3: Front left+ Front right+ Center

Changing subtitles **DVD-V** (with subtitles) **VCD** (SVCD only)

RAM **DVD-RW (VR)**

(On/Off only with discs that contain subtitle on/off information)

SUBTITLE  (Remote control)

 Menu
Subtitle ◀ Off ▶

DVD-V **VCD**

Press to select the subtitle language.

• On +R/+RW, a subtitle number may be shown for subtitles that are not displayed.

To clear/display the subtitles

Press [**◀▶**] to select "On" or "Off".

RAM **DVD-RW (VR)**

Press to select "On" or "Off".

• Subtitle on/off information cannot be recorded using Panasonic DVD Recorders.

• To exit the screen : Press [RETURN].

Angle select **DVD-V** (with multiple angles) / Still picture rotation **JPEG**

ANGLE  Press to select the angle or rotate the still picture.

(Remote control)

e.g. **DVD-V**

 Menu
Angle 1/4

- To exit the screen : Press [RETURN].

Enjoying higher quality audio and video

Multi Re-master

RAM **DVD-RW (VR)** **DVD-V** (Discs recorded with 48 kHz only) **VCD** **CD**

This feature gives you a more natural sound by adding the higher frequency signals not recorded on the disc.

WMA **MP3** (Disc recording is other than 8 kHz, 16 kHz or 32 kHz)

This feature reproduces the frequencies lost during recording to give you a sound closer to the original.

1 DISPLAY



Press once.

2



- ① Press [**▲▼**] to select Other Settings.
- ② Press [**▶**] to go to the next menu and [**▲▼**] to select "Audio Menu".
- ③ Press [**▶**] to go to the next menu and [**▲▼**] to select "Multi Re-master".
- ④ Press [**ENTER**] and [**▲▼**] to select "1", "2" or "3".
- ⑤ Press [**ENTER**].

• To exit the screen : Press [**RETURN**].

Setting	DVD-V CD (LPCM) Type of music	Other discs Effect level
1	High tempo (e.g., pop and rock)	Light
2	Various tempos (e.g., jazz)	Medium
3	Low tempo (e.g., classical)	Strong
Off	Off	Off

• Multi Re-master may not work when connecting with a digital optical cable (→ page 20).

Picture Mode

1 DISPLAY



Press once.

2

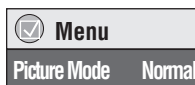

- ① Press [**▲▼**] to select Other Settings.
- ② Press [**▶**] to go to the next menu and [**▲▼**] to select "Picture Menu".
- ③ Press [**▶**] to go to the next menu and select "Picture Mode".
- ④ Press [**ENTER**] and [**▲▼**] to select "Normal", "Cinema1" or "Cinema2".
- ⑤ Press [**ENTER**].

Cinema1: Mellows images and enhances detail in dark scenes.

Cinema2: Sharpens images and enhances detail in dark scenes.

• To exit the screen : Press [**RETURN**].

Program/Random play Remote control only

DVD-V VCD CD WMA MP3 JPEG



While stopped
Press to change.

Program play \longleftrightarrow Random play
 \uparrow Off (Normal play) \leftarrow

- Disable HighMAT disc play to use random and program play.
Select "Play as Data Disc" in Other Menu. (→ page 17).

Program play (up to 32 items)

e.g. DVD-V

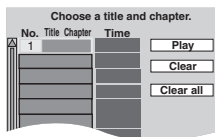

1



Press to select an item 2
(→ page 9).

Repeat this step to program other items.

PLAY



Selecting all the items (on the disc or in the title or group)

Press [ENTER] and [▲▼] to select "ALL", then press [ENTER] again to register.

Changing the program

Press [▲▼] to select an item.

–To change an item, repeat step 1.

–To clear an item, press [CANCEL] (or select "Clear" and press [ENTER]).

Clearing the whole program

Select "Clear all" and press [ENTER]. The whole program is also cleared when the unit is turned off or the disc lid is opened.

Random play

e.g. DVD-V



1

DVD-V WMA MP3 JPEG only



Press to select a group
or a title (→ page 9).

2

PLAY



To exit the program or random mode

Press [PLAYMODE] several times while stopped.

Playing data discs WMA MP3 JPEG

You can play JPEG files on DVD-RAM or play HighMAT discs without using the HighMAT function (→ page 17, "Play as Data Disc" in Other Menu).

Playing items in order (Playback Menu) (except JPEG files on DVD-RAM)



While the menu is displayed

Press [**▲▼**] to select "All", "Audio", or "Picture" and press [ENTER].

- To display/exit the screen : Press [TOP MENU].

Playing from the selected item (Navigation Menu)



Press.



Press [**▲▼◀▶**] to select the group and press [ENTER].

- To play content in the group in order: Press [ENTER].
- To start play from the selected content: Press [**▲▼**] to select and press [ENTER].

Group and content number currently playing

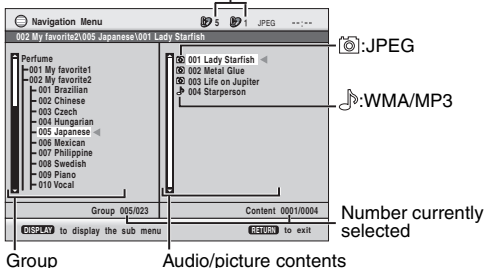

Group

Audio/picture contents

Number currently selected

- To listen to WMA/MP3 contents while showing a JPEG image on the screen
Select a JPEG file first, and then select WMA/MP3 contents. (The opposite order is not effective.)
- To exit the screen : Press [MENU].

Using the submenu

While the navigation menu (→ see above) is displayed.

Submenu

- 1 Press [DISPLAY].
- 2 Press [**▲▼**] to select the sub menu (→ see right) and press [ENTER].

Multi	Groups and content
List	Content only
Tree	Groups only
Thumbnail	Thumbnail images JPEG
Next group	To the next group WMA MP3
Previous group	To the previous group WMA MP3
All	WMA/MP3 and JPEG files
Audio	WMA/MP3 files only
Picture	JPEG files only
Help display	To switch between guide messages and the elapsed play time indicator
Find	To search by content or group title (→ see below)

Searching by a content or group title

Press [**◀▶**] to highlight a group title to search a group, or a content title to search its content.

- 1 Select "Find". (→ see above)
- 2 Press [**▲▼**] to select a character and press [ENTER].
 - Repeat to enter another character.
 - Lower case is also searched.
 - Press and hold [**◀▶**] to skip between A, E, I, O and U.
 - Press [**◀**] to erase a character.
 - Erase the asterisk (*) to search for titles starting with that character.
- 3 Press [**▶**] to select "Find" and press [ENTER]. The search result screen appears.
- 4 Press [**▲▼**] to select the content or group and press [ENTER].

Playing HighMAT™ discs

WMA MP3 JPEG



While the menu is displayed
Press [**▲▼◀▶**] to select items
and press [**ENTER**].



Menu:
Takes you to the next menu which shows playlists or another menu.
Playlist:
Play starts.

- To return to the menu screen, press [**TOP MENU**] then press [**RETURN**] several times.
- To change the menu background, press [**DISPLAY**]. The background changes to the one recorded on the disc.
- To display/exit the screen, press [**TOP MENU**].

Selecting from the list

1. During play, press [**MENU**].
 2. Press [**◀**] then [**▲▼**] to switch among "Playlist", "Group" and "Content" lists.
 3. Press [**▶**] then [**▲▼**] to select an item and press [**ENTER**].
- To exit the screen : Press [**MENU**].

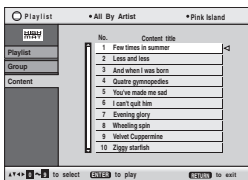

Playing programs/playlists on RAM/DVD-RW (DVD-VR) discs

RAM DVD-RW (VR)

- Titles appear only if they have been entered.
- You cannot edit playlists and titles.

1 To play programs:

TOP MENU



To play playlists:

MENU



2

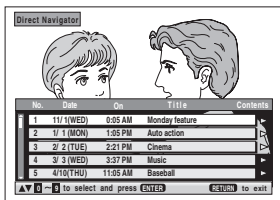

Press [**▲▼**] to select the program or playlist and press [**ENTER**].

- Only when the disc contains a playlist.

- You can also use the **numbered buttons** on the remote control (→ page 9).
- Press [**▶**] to show the contents of the program (Only when playing the program).
- To exit the screen : Press [**TOP MENU**] or [**MENU**].

Playing CD

CD

Titles appear with CD text playback.

1

MENU



e.g. CD text

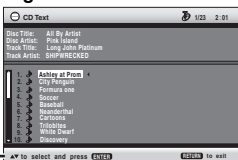

2



Press [**▲▼**] to select the tracks and press [**ENTER**].

- To exit the screen : Press [**MENU**].

Press [**DISPLAY**] to switch between guide messages and the elapsed play time indicator.

Using On-Screen Menus

1 **DISPLAY** Press once. 2



- ① Press [**▲▼**] to select the menu.
- ② Press [**▶▶**] to go to the next menu and [**▲▼**] to set.

Repeat step ② if necessary.

- Press [**◀◀**] to go to the previous menu.
- Items shown differ depending on the type of software.
- There are items which you can select using the **numbered buttons** and [**ENTER**] on the remote control.
- If the setting does **NOT** change, press [**ENTER**].
- To finish, press [**RETURN**].

Main menus

Program, Group, Title Chapter, Track, Playlist Content	To start from a specific item
Time	<p>To skip incrementally or decrementally* (Time Slip for play only)</p> <ol style="list-style-type: none"> 1. Press [ENTER] twice to show Time Slip indicator. 2. Press [▲▼] to select the time and press [ENTER]. <ul style="list-style-type: none"> • Press and hold [▲▼] to alter faster. <p>To start from a specific time* (Time Search) To change remaining/elapsed time display</p>
Audio	<p>(→ page 11, Changing soundtracks)</p> <p>To display the current bitrate or sampling frequency</p>
Thumbnail	To show thumbnail images
Subtitle	(→ page 11, Changing subtitles)
Marker(VR)	To recall a marker recorded on DVD-Video recorders
Angle	(→ page 11, Angle select)
Rotate picture	(→ page 11, Still picture rotation)
Slideshow	<p>To turn on/off slideshow</p> <p>To change the slideshow timing (0–30 sec)</p>
Other Settings	(→ See below)

* Except +R/+RW

Other Settings

Play Speed	(→ page 10, Changing play speed)
-------------------	----------------------------------

Play Menu (Only when the elapsed play time can be displayed,

JPEG: The Repeat and Marker functions can be used.)

Repeat	(→ page 10, Repeat play)
A-B Repeat	(→ page 10, A-B Repeat)
Marker Except RAM DVD-RW (VR)	<p>To mark up to 5 positions to play again [ENTER] (The unit is now ready to accept markers.)</p> <p>To mark a position: [ENTER] (at the desired point)</p> <p>To mark another position: [◀▶] to select "*" → [ENTER]</p> <p>To recall a marker: [◀▶] → [ENTER]</p> <p>To erase a marker: [◀▶] → [CANCEL] (Remote control)</p> <ul style="list-style-type: none"> • This feature doesn't work during program and random play. • Markers you add clear when you open the disc lid or switch the unit to standby.

Picture Menu

Picture Mode (→ page 12, Picture Mode)

Audio Menu

Advanced Surround (→ page 10, Enjoying virtual surround)

Dialogue Enhancer
To make the dialogue in movies easier to hear
DVD-V (Dolby Digital, DTS, 3-channel or over, with the dialogue recorded in the center channel)
On ↔ **Off**

Multi Re-master (→ page 12, Multi Re-master)

Display Menu

Information **On** ↔ **Off** (**JPEG**: **Off**, **Date**, **Details**)

Subtitle Position **0** to **-60** (in of 2 units)

Subtitle Brightness **Auto**, **0** to **-7**

Just Fit Zoom
RAM **DVD-RW (VR)** **DVD-V** **VCD**
 To expand the letterbox picture to fit the screen.
 Press [**▲▼**] to select the preset aspect ratio or "Auto".

Manual Zoom
RAM **DVD-RW (VR)** **DVD-V** **VCD**
 Press [**▲▼**] for fine adjustments. (Press and hold to alter faster.)
 -from ×1.00 to ×1.60 (in 0.01 units)
 -from ×1.60 to ×2.00 (in 0.02 units)

Bitrate Display **RAM** **DVD-RW (VR)** **DVD-V** **VCD** **On** ↔ **Off**

GUI See-through **On** ↔ **Off**

Other Menu

Setup (→ page 18, Changing the player settings)

Play as DVD-VR
Play as HighMAT
 or
Play as Data Disc
 • While stopped, select "Play as Data Disc" to play JPEG files on DVD-RAM or to play a HighMAT disc without using the HighMAT function.

Checking the play status (Elapsed play time indicator)

Press [**DISPLAY**] twice.

Condition—play, pause or slow/search

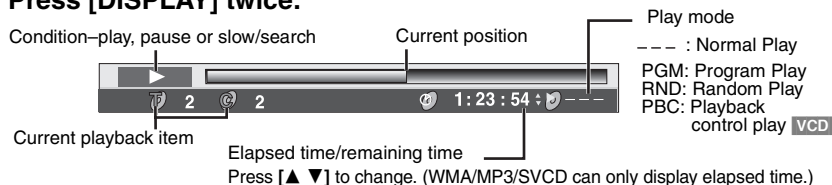

• To exit the screen : Press [**RETURN**].

Changing the player settings

Remote control only

- Referring to pages 18 to 19, change as required.
- Underlined items are the factory presets.

The settings remain intact even if you switch the unit to standby.

1



2



Press [**▲ ▼ ◀ ▶**] to select the menu, item, content and press [**ENTER**].

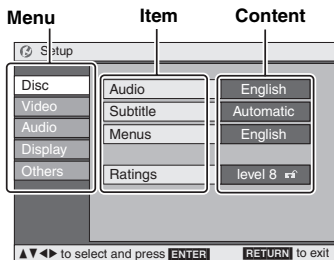

- To return to the previous screen, press [**RETURN**].
- To finish the SETUP menu, press [**SETUP**].
- While stopped, the menu is also displayed when [**MENU**] on the main unit is pressed; however, when a DVD-RAM or HighMAT CD is being used a playlist menu appears.

“Disc” tab



Audio	<ul style="list-style-type: none"> • <u>English</u> • French • Spanish • Original (The original language designated on the disc is selected) • Other*****
Subtitle	<ul style="list-style-type: none"> • <u>Automatic</u> [If the language selected for “Audio” is not available, subtitles appear in that language (If available on the disc).] • English • French • Spanish • Other*****
Menus	<ul style="list-style-type: none"> • <u>English</u> • French • Spanish • Other*****
Ratings Set a ratings level to limit DVD-Video playback. • Follow the on-screen instructions.	Setting ratings (When level 8 is selected) <ul style="list-style-type: none"> • <u>8 No Limit</u>. • 1 to 7: Prohibits play corresponding to ratings recorded on the disc. • 0 Lock All: To prevent play of discs without ratings levels. When setting a ratings level, a password screen is shown. Follow the on-screen instructions. <p>Do not forget your password.</p> <p>A message screen will be shown if a DVD-Video exceeding the ratings level is inserted in the unit. Follow the on-screen instructions.</p>

*Input a code number referring to the table on page 19.

“Video” tab

TV Aspect Choose the setting to suit your television and preference.	<ul style="list-style-type: none"> • 4:3 Pan&Scan: Regular aspect television (4:3) The sides of the widescreen picture are cut off so it fills the screen (unless prohibited by the disc). • 4:3 Letterbox: Regular aspect television (4:3) Widescreen picture is shown in the letterbox style. • <u>16:9</u>: Widescreen television Use the television's screen modes to change the way the picture is shown. 	
Still Mode Specify the type of picture shown when paused.	<ul style="list-style-type: none"> • <u>Automatic</u> • Field: The picture is not blurred, but picture quality is lower. • Frame: Overall quality is high, but the picture may appear blurred. 	

“Audio” tab

PCM Digital Output*	Check the digital input limitations of the equipment you connect and select the maximum sampling frequency of PCM digital output. Off: When not connected using a digital optical cable Up to 48 kHz: When connected to equipment compatible with 44.1 or 48 kHz Up to 96 kHz: When connected to equipment compatible with 88.2 or 96 kHz Up to 192 kHz: When connected to equipment compatible with 176.4 or 192 kHz ● Signals from copy-protected discs are converted to 48 or 44.1 kHz. ● Some equipment cannot handle sampling frequencies of 88.2 kHz, even if it can handle 96 kHz. Read your equipment's operating instructions for details.	
Dolby Digital™	Bitstream PCM	
DTS Digital Surround™	PCM Bitstream	
Dynamic Range Compression	<ul style="list-style-type: none"> ● Off ● On: Adjusts for clarity even when the volume is low through compressing the range of the lowest sound level and the highest sound level. Convenient for late night viewing. (Only works with Dolby Digital). 	
Audio during Search Choose whether to have sound during search	<ul style="list-style-type: none"> ● On ● Off 	

※ Only when connected using a digital optical cable (→ page 20)

“Display” tab

Menu Language	<ul style="list-style-type: none"> ● English ● Français ● Español
On-Screen Messages	<ul style="list-style-type: none"> ● On ● Off

“Others” tab

HighMAT Selects the play method for HighMAT discs	<ul style="list-style-type: none"> ● Enable: Plays as HighMAT ● Disable: Plays as WMA/MP3/JPEG
Re-initialize Setting This returns all values in the Setup menus to the default settings.	<ul style="list-style-type: none"> ● Yes: The password screen is shown if “Ratings” (→ page 18) is set. Please enter the same password and press [ENTER]. When “Initialized” appears on the screen, wait for about 10 seconds. Press [ENTER] and turn the unit off and on again. ● No

Language code list

Abkhazian: 6566	Chinese: 9072	Hindi: 7273	Malagasy: 7771	Samoan: 8377	Tibetan: 6679
Afar: 6565	Corsican: 6779	Hungarian: 7285	Malay: 7783	Sanskrit: 8365	Tigrinya: 8473
Afrikaans: 6570	Croatian: 7282	Icelandic: 7383	Malayalam: 7776	Scots Gaelic: 7168	Tonga: 8479
Albanian: 8381	Czech: 6783	Indonesian: 7378	Maltese: 7784	Serbian: 8382	Turkish: 8482
Ameharic: 6577	Danish: 6865	Interlingua: 7365	Maori: 7773	Serbo-Croatian: 8372	Turkmen: 8475
Arabic: 6582	Dutch: 7876	Irish: 7165	Marathi: 7782	Shona: 8378	Twi: 8487
Armenian: 7289	English: 6978	Italian: 7384	Moldavian: 7779	Sindhi: 8368	Ukrainian: 8575
Assamese: 6583	Esperanto: 6979	Japanese: 7465	Mongolian: 7778	Singhalese: 8373	Urdu: 8582
Aymara: 6589	Estonian: 6984	Javanese: 7487	Nauru: 7865	Slovak: 8375	Uzbek: 8590
Azerbaijani: 6590	Faroese: 7079	Kannada: 7578	Nepali: 7869	Slovenian: 8376	Vietnamese: 8673
Bashkir: 6665	Fiji: 7074	Kashmiri: 7583	Norwegian: 7879	Somali: 8379	Volapük: 8679
Basque: 6985	Finnish: 7073	Kazakh: 7575	Oriya: 7982	Spanish: 6983	Welsh: 6789
Bengali; Bangla: 6678	French: 7082	Kirghiz: 7589	Pashto, Pushto: 8083	Spanish: 6983	Wolof: 8779
Bhutanian: 6890	Frisian: 7089	Korean: 7579	Persian: 7065	Singhalese: 8373	Xhosa: 8872
Bihari: 6672	Galician: 7176	Laotian: 7679	Polish: 8076	Swahili: 8387	Yiddish: 7473
Breton: 6682	Georgian: 7565	Latin: 7665	Portuguese: 8084	Swedish: 8386	Yoruba: 8979
Bulgarian: 6671	German: 6869	Latvian, Lettish: 7686	Punjabi: 8065	Tagalog: 8476	Zulu: 9085
Burmese: 7789	Greek: 6976	Lingala: 7678	Quechua: 8185	Tajik: 8471	
Byelorussian: 6669	Greenlandic: 7576	Lithuanian: 7684	Rhaeto-Romance: 8277	Tamil: 8465	
Cambodian: 7577	Guarani: 7178	Lithuanian: 7684	Romanian: 8279	Tatar: 8484	
Catalan: 6765	Gujarati: 7185	Macedonian: 7775	Russian: 8285	Telugu: 8469	
	Hausa: 7265			Thai: 8472	
	Hebrew: 7387				

Using this unit with other equipment

Turn off all equipment before connecting and read the appropriate operating instructions.

Enjoying with 5.1ch audio

Left side of this unit



Digital optical cable (not included)

- Do not bend sharply.
- Align and insert.

AV amplifier with Dolby Digital/DTS logo (→ page 19)



OPTICAL IN

Connect the 6 speakers to the amplifier's 5.1ch audio output terminals.

- Change "PCM Digital Output", "Dolby Digital", and "DTS Digital Surround" (→ page 19).

Enjoying stereo audio

Left side of this unit



Audio cable (not included)

Black

Amplifier/System component

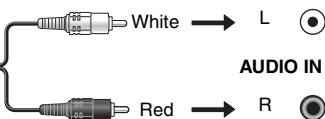

Television connections

Connect the video output from this unit directly to the television.

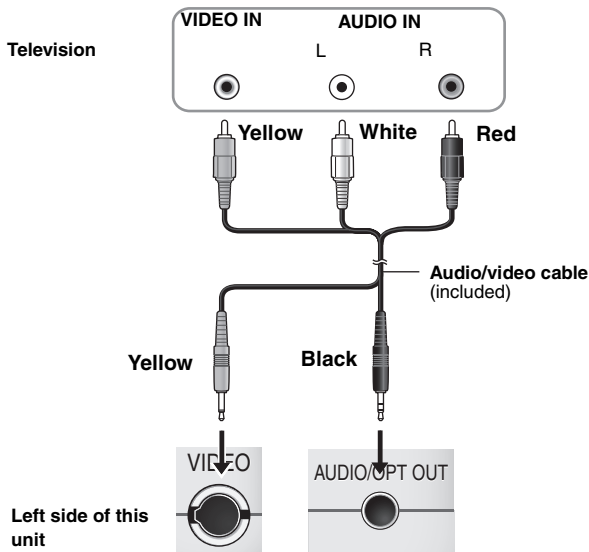

Using a Car DC Adaptor (included)

Do not leave the unit on a surface that may become hot such as a dashboard. The unit is not heat-resistant so may malfunction.

The driver must not operate this unit while the vehicle is moving.
Do not operate this unit where it can be viewed by the driver.
Driver operation or viewing of this unit while the vehicle is moving will cause distraction which may result in serious accident and personal injury or property damage.

Connections

Before connection, consult your car owner's manual or your dealer.

- Connect to the cigarette lighter socket of a vehicle that has a 12 V battery. It is not compatible with a vehicle that has a 24 V battery.
- This is a special negative grounded Car DC Adaptor. Using this Car DC Adaptor with a plus grounded car can cause malfunction and lead to fire.

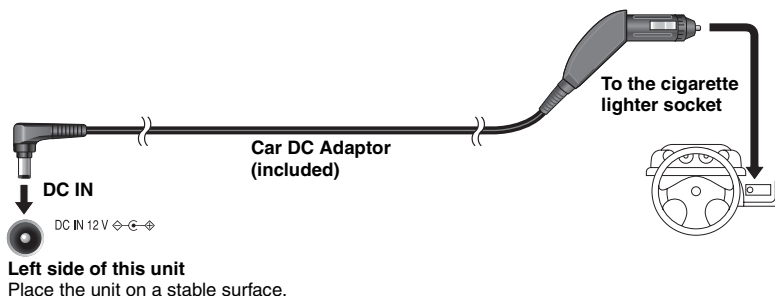

Replacing the fuse

Replace only with the specified 125 V/250 V, 2.5 A fuse. Use of any other type can cause fire.

2 Replace the fuse. (125 V/250 V, 2.5 A type)

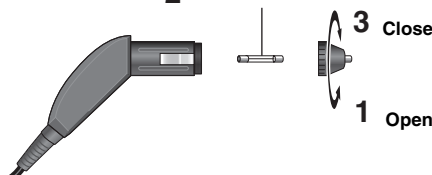

Cautions

- **To avoid draining your car battery**
 - Disconnect the Car DC Adaptor from the cigarette lighter after use. The Car DC Adaptor continues to consume some power even if it is not being used, and if a battery pack is attached to this unit, it will start recharging which uses more power.
 - Do not use the Car DC Adaptor for long periods when the engine is not running.
 - Do not recharge the battery pack with this Car DC Adaptor. Use the AC adaptor included with this unit.
- When starting an engine, pull Car DC Adaptor out of the cigarette lighter socket. Mishandling of the Car DC Adaptor can cause malfunction.
- No responsibility will be taken for damage that occurs due to faulty installation.
- Leave some slack in the cord.

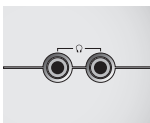

(Left side of this unit)

You can enjoy audio through your car audio system by connecting a car stereo cassette adaptor (not included: RP-CC20) to the headphone jack on the left side of this unit.

Frequently asked questions

Reference pages are shown in parentheses.

What kind of equipment is necessary to enjoy 5.1ch audio?	Connect to an AV amplifier (that has 5.1ch audio output terminals) displaying the Dolby Digital/DTS logo. (19)
Can I play a DVD-Video bought in another country?	You can play if the region number includes "1" or "ALL" and the video standard is NTSC. Check the disc jacket.
Can I use on an airplane or in a hospital?	Electromagnetic waves that are emitted from this unit may affect equipment on an airplane or in a hospital. Please obey the rules and/or instructions indicated by the hospital or airline.
Can I use in a car?	You can use this unit by connecting with the included Car DC Adaptor for power. Damage may occur if you do not use the specified car adaptor. (21)
Can I connect with a computer?	You can enjoy use of the computer as a television monitor when connecting with the AV input terminal on a computer. However, you cannot operate this unit as peripheral equipment.

Tips for making WMA/MP3 and JPEG discs (For CD-R/CD-RW)

- Discs must conform to ISO9660 level 1 or 2 (except for extended formats).
- This unit is compatible with multi-session but if there are a lot of sessions it takes more time for play to start. Keep the number of sessions to a minimum to avoid this.
- If groups were created away from the root like "002 group" in the illustration below, the eighth one and onwards are displayed on the same vertical line in the menu screen.
- There may be differences in the display order on the menu screen and computer screen.
- This unit cannot play files recorded using packet write.

Naming folders and files

(Files are treated as content and folders are treated as groups on this unit.)

At the time of recording, prefix folder and file names. This should be with numbers that have an equal number of digits, and should be done in the order you want to play them (this may not work at times).

Files must have the extension:

“.WMA” or “.wma”

“.MP3” or “.mp3”

“.JPG”, “.jpg”, “.JPEG” or “.jpeg”

WMA

- You cannot play WMA files that are copy protected.
- This unit is not compatible with Multiple Bit Rate (MBR: a file that contains the same content encoded at several different bit rates).

MP3

- This unit is not compatible with ID3 tags.
- Compatible sampling rate: 8, 11.02, 12, 16, 22.05, 24, 32, 44.1, and 48 kHz

JPEG

- JPEG files taken on a digital camera that conform to the DCF Standard Version 1.0 are displayed.
 - Pictures taken using digital camera functions not supported by DCF like automatic picture rotation may not be displayed.
 - Files that have been altered, edited or saved with computer picture editing software may not be displayed.
- This unit cannot display moving pictures, MOTION JPEG and other such formats, still pictures other than JPEG (e.g. TIFF) or play pictures with attached audio.

e.g. MP3

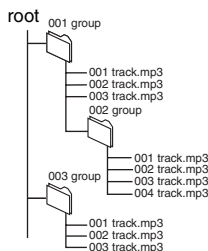

Specifications

Operating temperature range:

+5 to +35 °C (+41 to +95 °F)

Operating humidity range:

5 to 85 % RH (no condensation)

Discs played [8 cm (3 ") or 12 cm (5 ")]:

- (1) DVD (DVD-Video)
- (2) DVD-RAM (DVD-VR, JPEG^{#4,5})
- (3) DVD-R (DVD-Video)
- (4) DVD-RW (DVD-Video, DVD-VR)
- (5) +R/RW (Video)
- (6) CD, CD-R/RW [CD-DA, Video-CD, SVCD^{#1}, MP3^{#2,5}, WMA^{#3,5}, JPEG^{#4,5}, HighMAT Level 2 (Audio and Image)]

Signal system: NTSC

LCD screen: 9" α -Si, TFT wide-screen LCD

Composite-video output:

Output level: 1 Vp-p (75 Ω)
Output terminal: Mini-jack
Number of terminals: 1 system

Audio output:

Output level: 1.5 Vrms (1 kHz, 0 dB, 10 k Ω)
Output terminal: Stereo mini-jack
Number of terminals: 1 system

Audio performance:

- (1) Frequency response:
 - DVD (linear audio):
4 Hz to 22 kHz (48 kHz sampling)
4 Hz to 44 kHz (96 kHz sampling)
 - CD audio: 4 Hz to 20 kHz
- (2) S/N ratio:
 - CD audio: 115 dB
- (3) Dynamic range:
 - DVD (linear audio): 98 dB
 - CD audio: 97 dB
- (4) Total harmonic distortion:
 - CD audio: 0.008 %

Digital audio output:

Optical digital output: Mini optical terminal
Number of terminals: 1 system
(also used for audio output)

Pickup:

Wave length: 662 nm/785 nm (DVD/CD)
Laser power: CLASS II/CLASS I (DVD/CD)

Power supply: DC 12 V (DC IN terminal)/
DC 7.2 V (Exclusive battery terminal)

Power consumption (using included AC adaptor):
13 W (Unit only: 10 W)

Power consumption in Standby mode
(using included AC adaptor):

approx. 0.5 W

Power consumption in Recharge mode
(using included AC adaptor):

13 W

AC adaptor:

Power source: AC 100 to 240 V, 50/60 Hz

Power consumption: 28 W

DC output: 12 V, 1.5 A

Car DC Adaptor:

DC input: 12 V, 20 W

DC output: 12 V, 1.5 A

Battery pack (lithium ion)

CGR-H702 (DVD-LS90) included:

Voltage: 7.2 V

Capacity: 4700 mAh

CGR-H703 (DVD-LS93) included:

Voltage: 7.2 V

Capacity: 8600 mAh

Dimensions (W×D×H)

(excluding protrusions and battery):

DVD-LS90: 235.4 mm×178.6 mm×39.0* mm
(9 ⁹/₃₂"×7 ¹/₃₂"×1 ¹⁷/₃₂"

*29.9 mm (1 ³/₁₆") at lowest point

[D=185 mm (7 ⁹/₃₂") including battery]

[H=51.5 mm (2 ¹/₃₂") including battery]

DVD-LS93: 235.4 mm×178.6 mm×39.0* mm
(9 ⁹/₃₂"×7 ¹/₃₂"×1 ¹⁷/₃₂"

*29.9 mm (1 ³/₁₆") at lowest point

[D=201.4 mm (7 ¹⁵/₁₆") including battery]

[H=51.5 mm (2 ¹/₃₂") including battery]

Mass (including battery):

DVD-LS90: 1097 g (38.69 oz)

DVD-LS93: 1280 g (45.15 oz)

Note

Specifications are subject to change without notice. Mass and dimensions are approximate.

*1 Conforming to IEC62107

*2 Compatible compression rate: between
32 kbps and 320 kbps

*3 Compatible compression rate: between
48 kbps and 320 kbps

*4 Exif Ver 2.1 JPEG Baseline files
Picture resolution: between 320×240 and
6144×4096 pixels (Sub sampling is 4:2:2 or
4:2:0)

*5 The total combined maximum number of
recognizable audio and picture contents and
groups: 4000 audio and picture contents and
400 groups.

Troubleshooting guide

Before requesting service, make the following checks. If you are in doubt about some of the check points, or if the remedies indicated in the chart do not solve the problem, refer to the "Customer Services Directory" on page 29 if you reside in the U.S.A., or refer to the "Product information" on page 29 if you reside in Canada. In other areas, consult your dealer for instructions. (Reference pages are shown in parentheses.)

The following do not indicate malfunction.

- Sound from the AC adaptor during recharging.
- The battery pack warming up when recharging or during use.
- The surface and area around the unit becoming warm when used for long periods.

Power

No power.	<ul style="list-style-type: none"> ● Check connections to the AC adaptor or battery pack. (6) ● You cannot turn on the unit with the remote control if the unit is powered by the battery pack. ● The unit has protection circuitry that is activated if it becomes too hot or too cold. The unit will not work if this occurs. Use the unit between 5 °C (41 °F) and 35 °C (95 °F).
Unit turns off automatically.	<ul style="list-style-type: none"> ● The unit turns off after it has been stopped for about 15 minutes (5 minutes when the unit is powered by the battery pack) to conserve power. Turn the unit on again.
Cannot charge or the [CHG] indicator fails to light.	<ul style="list-style-type: none"> ● The battery pack can only be recharged when the unit is off. ● The charging time increases when the temperature is too hot or too cold, and charging may not be possible under some circumstances. ● Check connections to the AC adaptor or battery pack. (6)
Play time dramatically reduced after recharging.	<ul style="list-style-type: none"> ● The battery pack has reached the end of its service life (It can be recharged about 300 times).

No operation

No response when any buttons pressed.	<ul style="list-style-type: none"> ● This unit cannot play discs other than the ones listed in these operating instructions. (5) ● The unit may not be operating properly due to lightning, static electricity or some other external factor. Turn the unit off and then back to ON. Alternatively, turn the unit off, disconnect the power source (AC or battery pack), and then reconnect it. ● Condensation has formed: Wait 1 to 2 hours for it to evaporate.
No response when remote control buttons pressed.	<ul style="list-style-type: none"> ● Check that the battery is installed correctly. (7) ● The battery is depleted: Replace it with new one. (7) ● Point the remote control at the remote control sensor and operate. (7)
You have forgotten your ratings password. Reset all the settings to Factory Preset.	<ul style="list-style-type: none"> ● While stopped, press and hold [◀◀] and [■] on the unit and then also press and hold [▶, ON] on the unit until "Initialized" disappears from the screen. Turn the unit off and on again. All settings will return to the default values.
No picture or sound.	<ul style="list-style-type: none"> ● Check that the disc has something recorded on it.

Specific operation impossible or incorrect

It takes time before play starts. [MP3]	<ul style="list-style-type: none">• Play may take time to begin when an MP3 track has still picture data. Even after the track starts, the correct play time will not be displayed; however, this is normal.
The program and random play functions do not work. [DVD-V]	<ul style="list-style-type: none">• These functions do not work with some DVD-Videos.
Menu doesn't appear. [VCD] with playback control	<ul style="list-style-type: none">• Press [■] twice and then press [▶] (PLAY).
Subtitle position is wrong.	<ul style="list-style-type: none">• Adjust the position. ("Subtitle Position" in Display Menu) (17)
No subtitles.	<ul style="list-style-type: none">• Display the subtitles. (11)
The subtitles overlap closed captions recorded on discs.	<ul style="list-style-type: none">• Clear the subtitles. (11)
In A-B repeat, point B is automatically set.	<ul style="list-style-type: none">• The end of an item becomes point B when it is reached.
Play doesn't start. [WMA]	<ul style="list-style-type: none">• This unit may not play WMA that contains still picture data.

Picture incorrect

No picture on the LCD.	<ul style="list-style-type: none">• Select a monitor mode other than "OFF" (no picture). (11, Selecting how to show 4:3 aspect pictures on the LCD).
The LCD is dark.	<ul style="list-style-type: none">• Adjust the brightness. (11)
LCD pixels turn black or radiate different colors.	<ul style="list-style-type: none">• The LCD is constructed with precision technology so 99.99 % of the pixels are active, but of the remaining of 0.01 %, there are pixels that may be black or emit light constantly. This phenomenon is not a malfunction.
Picture doesn't appear on the television (or the size of the picture seems wrong).	<ul style="list-style-type: none">• Check connections. (20)• Check that the television is on.• Check that the input mode on the television is correct.• Check the settings in "Video—TV Aspect". (18)• Turn off the zooming feature on your television if you are using Zoom. (17)• Ensure that the unit is connected directly to the television, and is not connected through a video cassette recorder. (20)
Menu not displayed correctly.	<ul style="list-style-type: none">• Restore the zoom ratio to $\times 1.00$. (17)• Set "Subtitle Position" in Display Menu to "0". (17)
Auto zoom function does not work well.	<ul style="list-style-type: none">• Use the other preset aspect ratios or manual adjustment. (17)• Zoom function may not work well, especially in dark scenes and may not work depending on the type of disc.

Troubleshooting guide





Sound incorrect

Sound distorted.	<ul style="list-style-type: none"> • Select "Off" in "Advanced Surround". (10) • Move unit away from mobile phones. • Noise may occur when playing WMA files.
Piercing noise comes from the speakers.	<ul style="list-style-type: none"> • If you have connected a digital amplifier which does not include decoder, be sure to select "PCM" in "Dolby Digital" or "DTS Digital Surround" in "Audio" tab. (19)
Effects do not work.	<ul style="list-style-type: none"> • None of the audio effects work when the unit is connected through the digital optical cable and is outputting bitstream signals. (20) • Some audio effects do not work or have less effect with some discs. • Advanced Surround and Multi Re-master do not work if you have changed the play speed.
No sound from the unit's speaker.	<ul style="list-style-type: none"> • The speaker is off if the LCD is closed or headphones are connected. • Turn up the volume. (8)
No sound from other speakers.	<ul style="list-style-type: none"> • Check all connections and settings. (20)
No sound when you change the play speed.	<ul style="list-style-type: none"> • There may be a pause in sound.

Recording

Cannot record to digital recording equipment. (Incorrect sound recorded.)	<ul style="list-style-type: none"> • You cannot record WMA/MP3. • You cannot record DVDs that have protection preventing digital recording. • You cannot record DVDs if the recording equipment cannot handle signals with a sampling frequency of 48 kHz. • Make the following settings: <ul style="list-style-type: none"> – Advanced Surround: Off (10) – PCM Digital Output: Up to 48 kHz (19) – Dolby Digital/DTS Digital Surround: PCM (19)
---	--

Displays

" 	<ul style="list-style-type: none"> • The operation is prohibited by the unit or disc.
No On-Screen display.	<ul style="list-style-type: none"> • Select "On" for "On-Screen Messages" in "Display" tab. (19)
"Check the disc."	<ul style="list-style-type: none"> • Clean the disc. (27)
"  ERROR 01"	<ul style="list-style-type: none"> • A problem has occurred with the battery pack. Consult your dealer.
"  ERROR 02"	<ul style="list-style-type: none"> • The battery pack has been recharging for 12 hours but has failed to recharge for some reason. Recharge again.
"  ERROR 03"	<ul style="list-style-type: none"> • You are recharging in a location that is too hot or too cold. Recharge at normal temperature [+5 to +35 °C (+41 to +95 °F)].
"H □□" □□ stands for a number.	<ul style="list-style-type: none"> • Trouble has occurred. The number appearing after "H" depends on the problem. Turn the unit off and on again. Alternatively, turn the unit off, disconnect the power source (AC or battery pack), reconnect the power and turn the unit on again. If the service numbers fail to clear, note the service numbers and consult your dealer.
"Cannot display group xx, content xx"	<ul style="list-style-type: none"> • You are trying to play incompatible groups or content. (22)

[⏻] and [CHG] indicators

The [⏻] indicator flashes rapidly.

- The unit has malfunctioned. Consult your dealer.

The [⏻] indicator flashes slowly.

- The unit is on and the LCD is closed or the monitor mode is set to "OFF" (no picture). Turn the unit off when you have finished.

The [CHG] indicator flashes rapidly.

- There is a problem with the battery pack. Turn the unit on and check the message on the LCD. (26)

The [CHG] indicator flashes slowly.

- Battery pack charge is low. The unit will turn off automatically after a few minutes.

Maintenance

To clean this unit, wipe with a soft, dry cloth.

- Use eyeglass cleaner to remove stubborn dirt from the LCD.
- Never use alcohol, paint thinner or benzine to clean this unit.

Maintenance of the lens

- Remove dust carefully with an air blower for camera lenses (optional).
- Recommended product:
 - Lens cleaner kit (SZZP1038C)
(Available from Panasonic dealers.)
- You cannot use a CD type lens cleaner.
- Be careful not to touch the lens with your fingers.

To clean discs

- Wipe with a damp cloth and then wipe dry.

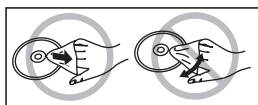

Disc handling precautions

- Do not attach labels or stickers to discs (This may cause disc warping, rendering it unusable).
- Do not write on the label side with a ball-point pen or other writing instrument.
- Do not use record cleaning sprays, benzine, thinner, static electricity prevention liquids or any other solvent.
- Do not use scratch-proof protectors or covers.
- Do not use the following discs:
 - Discs with exposed adhesive from removed stickers or labels (rented discs etc).
 - Discs that are badly warped or cracked.
 - Irregularly shaped discs, such as heart shapes.

User memo:

DATE OF PURCHASE _____
DEALER NAME _____
DEALER ADDRESS _____

TELEPHONE NUMBER _____

The model number and serial number of this product can be found on either the back or the bottom of the unit. Please note them in the space provided below and keep for future reference.

MODEL NUMBER _____
SERIAL NUMBER _____

Limited Warranty (ONLY FOR U.S.A.)

Panasonic Consumer Electronics Company,
Division of Panasonic Corporation of North
America
One Panasonic Way Secaucus,
New Jersey 07094

Panasonic Puerto Rico, Inc.
Ave. 65 de Infantería, Km. 9.5
San Gabriel Industrial Park, Carolina,
Puerto Rico 00985

Panasonic DVD Player Limited Warranty

Limited Warranty Coverage

If your product does not work properly because of a defect in materials or workmanship, Panasonic Consumer Electronics Company or Panasonic Puerto Rico, Inc. (collectively referred to as "the warrantor") will, for the length of the period indicated on the chart below, which starts with the date of original purchase ("Limited Warranty period"), at its option either (a) repair your product with new or refurbished parts, or (b) replace it with a new or a refurbished product. The decision to repair or replace will be made by the warrantor.

Product or Part Name	Parts	Labor
DVD Player	One (1) Year	Ninety (90) Days
Rechargeable Batteries (in exchange for defective item)	Ten (10) Days	Not Applicable

During the "Labor" Limited Warranty period there will be no charge for labor. During the "Parts" warranty period, there will be no charge for parts. You must mail-in your product during the warranty period. If non-rechargeable batteries are included, they are not warranted. This Limited Warranty only applies to products purchased and serviced in the United States or Puerto Rico. This Limited Warranty is extended only to the original purchaser and only covers product purchased as new. A purchase receipt or other proof of original purchase date is required for Limited Warranty service.

Mail-In Service

For assistance in the continental U.S.A. in obtaining repairs please ship the product to:

**Panasonic Services Company
Customer Service Center
Suite B
4900 George McVay Drive
McAllen, TX 78503**

For assistance in Puerto Rico call Panasonic Puerto Rico, Inc. (787)-750-4300 or fax (787)-768-2910.

When shipping the unit carefully pack and send it prepaid, adequately insured and preferably in the original carton. Include a letter detailing the complaint and provide a day time phone and/or email address where you can be reached.

IF REPAIR IS NEEDED DURING THE LIMITED WARRANTY PERIOD THE PURCHASER WILL BE REQUIRED TO FURNISH A SALES RECEIPT/PROOF OF PURCHASE INDICATING DATE OF PURCHASE, AMOUNT PAID AND PLACE OF PURCHASE. CUSTOMER WILL BE CHARGED FOR THE REPAIR OF ANY UNIT RECEIVED WITHOUT SUCH PROOF OF PURCHASE.

Limited Warranty Limits And Exclusions

This Limited Warranty ONLY COVERS failures due to defects in materials or workmanship, and DOES NOT COVER normal wear and tear or cosmetic damage. The Limited Warranty ALSO DOES NOT COVER damages which occurred in shipment, or failures which are caused by products not supplied by the warrantor, or failures which result from accidents, misuse, abuse, neglect, mishandling, misapplication, alteration, faulty installation, set-up adjustments, misadjustment of consumer controls, improper maintenance, power line surge, lightning damage, modification, or commercial use (such as hotel, office, restaurant, or other business), rental use of the product, or service by anyone other than a Factory Servicenter or other Authorized Servicer, or damage that is attributable to acts of God.

THERE ARE NO EXPRESS WARRANTIES EXCEPT AS LISTED UNDER "LIMITED WARRANTY COVERAGE". THE WARRANTOR IS NOT LIABLE FOR INCIDENTAL OR CONSEQUENTIAL DAMAGES RESULTING FROM THE USE OF THIS PRODUCT, OR ARISING OUT OF ANY BREACH OF THIS WARRANTY. (As examples, this excludes damages for lost time, cost of having someone remove or re-install an installed unit if applicable, travel to and from the servicer, loss of or damage to media or images, data or other recorded content. The items listed are not exclusive, but are for illustration only.) **ALL EXPRESS AND IMPLIED WARRANTIES, INCLUDING THE WARRANTY OF MERCHANTABILITY, ARE LIMITED TO THE PERIOD OF THE LIMITED WARRANTY.**

Some states do not allow the exclusion or limitation of incidental or consequential damages, or limitations on how long an implied Limited Warranty lasts, so the exclusions may not apply to you.

This Limited Warranty gives you specific legal rights and you may also have other rights which vary from state to state. If a problem with this product develops during or after the Limited Warranty period, you may contact your dealer or Servicenter. If the problem is not handled to your satisfaction, then write to the warrantor's Consumer Affairs Department at the addresses listed for the warrantor.

PARTS AND SERVICE, WHICH ARE NOT COVERED BY THIS LIMITED WARRANTY, ARE YOUR RESPONSIBILITY.

Limited Warranty (ONLY FOR U.S.A.)

Customer Services Directory

Obtain Product Information and Operating Assistance; locate your nearest Dealer or Servicenter; purchase Parts and Accessories; or make Customer Service and Literature requests by visiting our Web Site at:

<http://www.panasonic.com/consumersupport>

or, contact us via the web at:

<http://www.panasonic.com/contactinfo>

You may also contact us directly at:

1-800-211-PANA (7262),

Monday-Friday 9 am-9 pm; Saturday-Sunday 10 am-7 pm, EST.

For hearing or speech impaired TTY users, TTY: 1-877-833-8855

Accessory Purchases

Purchase Parts, Accessories and Instruction Books online for all Panasonic Products by visiting our Web Site at:

<http://www.pasc.panasonic.com>

or, send your request by E-mail to:

npcparts@us.panasonic.com

You may also contact us directly at:

1-800-332-5368 (Phone) 1-800-237-9080 (Fax Only) (Monday – Friday 9 am to 8 pm, EST.)

Panasonic Services Company

20421 84th Avenue South, Kent, WA 98032

(We Accept Visa, MasterCard, Discover Card, American Express, and Personal Checks)

For hearing or speech impaired TTY users, TTY : 1-866-605-1277

Service in Puerto Rico

Panasonic Puerto Rico, Inc.

Ave. 65 de Infantería, Km. 9.5, San Gabriel Industrial Park, Carolina, Puerto Rico 00985

Phone (787)750-4300, Fax (787)768-2910

F1104

Product Service

- 1. Damage requiring service**—The unit should be serviced by qualified service personnel if:
 - (a) The AC power supply cord or AC adaptor has been damaged; or
 - (b) Objects or liquids have gotten into the unit; or
 - (c) The unit has been exposed to rain; or
 - (d) The unit does not operate normally or exhibits a marked change in performance; or
 - (e) The unit has been dropped or the cabinet damaged.
- 2. Servicing**—Do not attempt to service the unit beyond that described in these operating instructions. Refer all other servicing to authorized servicing personnel.
- 3. Replacement parts**—When parts need replacing ensure the servicer uses parts specified by the manufacturer or parts that have the same characteristics as the original parts. Unauthorized substitutes may result in fire, electric shock, or other hazards.
- 4. Safety check**—After repairs or service, ask the servicer to perform safety checks to confirm that the unit is in proper working condition.

Product information

For product information or assistance with product operation:

In the U.S.A., refer to "Customer Services Directory" above.

In Canada, contact the Panasonic Canada Inc. Customer Care Centre at 1-800-561-5505, or visit the website (www.panasonic.ca), or an authorized Servicentre closest to you.

Limited Warranty (ONLY FOR CANADA)

Panasonic Canada Inc.

5770 Ambler Drive, Mississauga, Ontario L4W 2T3

PANASONIC/TECHNICS PRODUCT—LIMITED WARRANTY

Panasonic Canada Inc. warrants this product to be free from defects in material and workmanship and agrees to remedy any such defect, or at its option, replace the product for a period as stated below from the date of original purchase.

Technics Audio Product
Panasonic Audio & DVD Product
Accessories including rechargeable batteries

One (1) year, parts and labour
One (1) year, parts and labour
Ninety (90) days

LIMITATIONS AND EXCLUSIONS

This warranty does not apply to products purchased outside Canada or to any product which has been improperly installed, subjected to usage for which the product was not designed, misused or abused, damaged during shipping, or which has been altered or repaired in any way that affects the reliability or detracts from the performance, nor does it cover any product which is used commercially. Dry cell batteries are also excluded from coverage under this warranty. This warranty is extended to the original end user purchaser only. A purchase receipt or other proof of date of original purchase is required before warranty service is performed.

THIS EXPRESS, LIMITED WARRANTY IS IN LIEU OF ALL OTHER WARRANTIES, EXPRESS OR IMPLIED, INCLUDING ANY IMPLIED WARRANTIES OF MERCHANTABILITY AND FITNESS FOR A PARTICULAR PURPOSE.

IN NO EVENT WILL PANASONIC CANADA INC. BE LIABLE FOR ANY SPECIAL, INDIRECT OR CONSEQUENTIAL DAMAGES.

In certain instances, some jurisdictions do not allow the exclusion or limitation of incidental or consequential damages, or the exclusion of implied warranties, so the above limitations and exclusions may not be applicable.

WARRANTY SERVICE

For product operation and information assistance, please contact your Dealer or our Customer Care Centre at: Telephone #: (905) 624-5505 Fax #: (905) 238-2360 Web: www.panasonic.ca

For product repairs, please contact one of the following:

- Your Dealer who will inform you of an authorized Servicentre nearest you.
- Our Customer Care Centre at (905) 624-5505 or www.panasonic.ca
- A Panasonic Factory Servicentre listed below:

Richmond,

British Columbia

Panasonic Canada Inc.
12111 Riverside Way
Richmond, BC
V6W 1K8
Tel: (604) 278-4211
Fax: (604) 278-5627

Calgary, Alberta

Panasonic Canada Inc.
6835-8th St. N. E.
Calgary, AB
T2E 7H7
Tel: (403) 295-3955
Fax: (403) 274-5493

Mississauga, Ontario

Panasonic Canada Inc.
5770 Ambler Dr.
Mississauga, ON
L4W 2T3
Tel: (905) 624-8447
Fax: (905) 238-2418

Lachine, Québec

Panasonic Canada Inc.
3075, rue Louis A. Amos
Lachine, QC
H8T 1C4
Tel: (514) 633-8684
Fax: (514) 633-8020

IF YOU SHIP THE PRODUCT TO A SERVICENTRE

Carefully pack and send prepaid, adequately insured and preferably in the original carton.
Include details of the defect claimed, and proof of date of original purchase.

Manufactured under license from Dolby Laboratories. "Dolby" and the double-D symbol are trademarks of Dolby Laboratories.

"DTS" and "DTS 2.0 + Digital Out" are trademarks of Digital Theater Systems, Inc.

Apparatus Claims of U.S. Patent Nos. 4,631,603, 4,577,216, and 4,819,098, licensed for limited viewing uses only.

This product incorporates copyright protection technology that is protected by method claims of certain U.S. patents and other intellectual property rights owned by Macrovision Corporation and other rights owners. Use of this copyright protection technology must be authorized by Macrovision Corporation, and is intended for home and other limited viewing uses only unless otherwise authorized by Macrovision Corporation. Reverse engineering or disassembly is prohibited.

MPEG Layer-3 audio decoding technology licensed from Fraunhofer IIS and Thomson multimedia.

HighMAT™ and the HighMAT logo are either trademarks or registered trademarks of Microsoft Corporation in the United States and/or other countries.



Windows Media, and the Windows logo are trademarks, or registered trademarks of Microsoft Corporation in the United States and/or other countries.

WMA is a compression format developed by Microsoft Corporation. It achieves the same sound quality as MP3 with a file size that is smaller than that of MP3.



Listening caution



Do not play your headphones or earphones at a high volume. Hearing experts advise against continuous extended play.

If you experience a ringing in your ears, reduce volume or discontinue use.

Do not use while operating a motorized vehicle. It may create a traffic hazard and is illegal in many areas. You should use extreme caution or temporarily discontinue use in potentially hazardous situations.

Even if your headphones or earphones are the open-air type designed to let you hear outside sounds, don't turn up the volume so high that you can't hear what's around you.

Sound can be deceiving. Over time your hearing "comfort level" adapts to higher volumes of sound. So what sounds "normal" can actually be loud and harmful to your hearing.

Guard against this by setting your equipment at a safe level BEFORE your hearing adapts.

To establish a safe level:

- Start your volume control at a low setting.
 - Slowly increase the sound until you can hear it comfortably and clearly, and without distortion.
- Once you have established a comfortable sound level:
- Leave it there.

Do not rest the unit on your lap for a long time while using it. The unit can become hot and cause burns.

To prevent damage

Avoid the following:

- Spraying flammable insecticides near the unit.
- Pressing the LCD.
- Touching the lens and other parts of the laser pickup.

Do not use the unit in the following places:

- Sandy places such as beaches.
- On top of cushions, sofas, or hot equipment such as amplifiers.

Do not leave in an unventilated automobile or exposed to direct sunlight and high temperatures.

Main feature index

To select the content to **repeat** (→ page 10)

To enjoy **virtual surround** (→ page 10)

To adjust the **picture quality** (→ page 11)

To select how to **show 4:3 aspect pictures**
(→ page 11)

Shows a **disc top menu** (→ page 9)

Shows a **program list** (→ page 15)

Shows **On-Screen Menus** (→ page 16)

Shows a **disc menu** (→ pages 9, 14)

Shows a **playlist** (→ page 15)

Adjusts the **volume** (→ page 8)

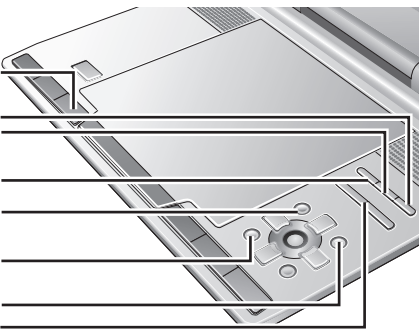

Shows a **disc top menu** (→ page 9)

Shows a **program list** (→ page 15)

Adjusts the **volume** (→ page 8)

Shows a **disc menu** (→ pages 9, 14)

Shows a **playlist** (→ page 15)

Changes **angles** (→ page 11)

Still picture rotation (→ page 11)

Changes **subtitles** (→ page 11)

Changes **soundtracks** (→ page 11)

program/random play (→ page 13)

Clears **an item** (→ page 13)

Shows **On-Screen Menus** (→ page 16)

U.S.A.

**Panasonic Consumer Electronics Company,
Division of Panasonic Corporation of North
America**

One Panasonic Way Secaucus,
New Jersey 07094

<http://www.panasonic.com>

Canada

Panasonic Canada Inc.

5770 Ambler Drive, Mississauga, Ontario L4W 2T3

www.panasonic.ca

Others

**Matsushita Electric Industrial Co., Ltd. Corporate
Management Division for the Americas
Sales Office for North America**

Tokyo Panasonic Sales Section
32nd Floor, World Trade Center 4-1,
Hamamatsu-cho, 2-Chome, Minato-Ku,
Tokyo 105-6132, Japan

Panasonic Puerto Rico, Inc.

Ave. 65 de Infantería, Km. 9.5
San Gabriel Industrial Park, Carolina,
Puerto Rico 00985

En

**Panasonic Marketing Europe G.M.B.H.
Wiesbaden N. (a Division of Panasonic
Marketing G.M.B.H.)**

Military Sales Department
6200 Wiesbaden-Biebrich,
Hagenauerstr. 43 Germany